



## K282 BOSTONIAN - LED

Similar to our popular K805 and K705, the K282 Bostonian offers an intermediately sized version. With its heavy wall aluminum casting and high performing optical system, its suitable for a variety of contemporary settings including roadway lighting, parking lots, walkways, waterfronts and recreational areas.



# King Luminaire

## PRODUCT SPECIFICATIONS

### LED ENGINE

Light engine shall include an array of 30 solid state Cree X-Series high power LEDs (light emitting diodes). The emitters shall be mounted to a metal core circuit board using SMT technology. The LEDs and circuit boards shall then be mounted to a high performance heat sink.

### OPTICS

External light control shall consist of high precision refractive lenses mounted above the LED emitter arrays in such a way to achieve optimum uplight control. The lenses shall also control horizontal light distribution so that Type III or V IESNA distribution patterns are achieved.

### LENS

The K282 Bostonian pendant is available with or without a lens. Lens options include rippled glass (borosilicate) shallow, acrylic shallow refractive, polycarbonate shallow refractive, clear glass (borosilicate) sag, and clear glass (borosilicate) shallow. The lens is secured by means of a cast A319 aluminum globe ring that is sealed with a continuous circular gasket.

### LUMINAIRE CONSTRUCTION

The luminaire shall consist of a heavy cast aluminum housing that acts as the enclosure for the engine and is of adequate thickness to give structural rigidity. The engine must be affixed to the inside of the housing with stainless steel screws.

The bottom decorative portion of the K282 Bostonian is comprised of a one-piece spun aluminum alloy with a minimum thickness of 0.09". The spinning is permanently affixed to the cast housing with the use of stainless steel hardware.

### PLUMBIZER

The K282 Bostonian comes with multiple mounting options including the KPL10, KPL11, KPL20, KPL21, KPL30, KPL31 and KPL40. Please contact King Luminaire for more details and specifications.

### DRIVER

The LED universal dimmable driver will be class 2 and capable of 120 - 277V or 347 - 480V input voltage, greater than 0.9 power factor, less than 20% total harmonic distortion. The case temperature of the driver can range from -40°C up to 70°C. Each LED system comes with a standard surge protection designed to withstand up to 20kV/10kA of transient line surge as per IEEE C62.41.2 C High. An in-line ferrite choke is utilized to provide protection against EFT's. The driver assembly will be mounted on a heavy duty fabricated aluminum bracket to allow complete tool-less maintenance. Dimming capable using 1-10vdc (10% to 100%), 10v PWM, or resistance.

### PHOTOMETRICS

Fixtures are tested to IESNA LM79 specifications. These reports are available upon request.

### CHROMATICITY

High output LEDs come standard at 3000K & 4000K (+/- 300K) with a minimum nominal 70 CRI. Additional CCT emitters are available upon request.

### LUMEN MAINTENANCE

Reported (TM21) and Calculated (L70) reports are available upon request with a minimum calculated value of 100,000 hrs.

### WIRING

All internal wiring and connections shall be completed so that it will be necessary only to attach the incoming supply connectors to Mate-N-Lok connectors or to a terminal block. Mate-N-Lok shall be certified for 600V operation. Internal wire connectors shall be crimp connector only and rated at 1000V and 150°C. All wiring to be CSA certified and/or UL listed, type SFF-2, SEWF-2, or SEW-2 No. 14 gauge, 150°C, 600V, and color coded for the required voltage.

### THERMALS

Fixtures tested to DOE sanc-

tioned standards to determine the maximum in-situ solder-point or junction-point temperatures of the LED emitters. This report is available upon request.

### FINISH

Housing is finished with a 13 step KingCoat™ SuperDurable polyester TGIC powder coat. Standard colors include strobe white, brown metal, marina blue, gate gray, Chicago bronze, standard gold, standard black, federal green and rain forest. Please see our website for a complete list of colors. RAL and custom color matches are available.

### MISCELLANEOUS

All exterior hardware and fasteners, wholly or partly exposed, shall be stainless steel alloy. All internal fasteners are stainless steel or zinc coated steel. All remaining internal hardware is stainless steel, aluminum alloy, or zinc coated steel.

### WARRANTY

The K282 Bostonian LED luminaire comes with a 7 year limited warranty.

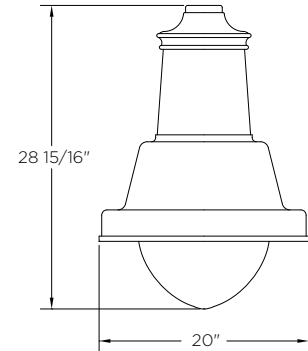

### CERTIFICATION:

CSA US Listed  
Suitable for wet locations  
ISO 9001  
IP66  
ARRA Compliant  
LM79 / LM80 Compliant

### DRIVER INFO:

>0.9 Power Factor  
<20% Total Harmonic Distortion  
120 - 277V & 347 - 480V  
-40°C Min. Case Temperature  
70°C Max. Case Temperature  
Surge Protection: ANSI C136.2  
extreme level 20kV/10kA  
Dimming Capable: 1-10vdc

### EPA:

Shallow Lens: 1.83 sq. ft.

### FIXTURE WEIGHT:

Shallow Lens: 31 lbs



Contact King Luminaire for product specifications that are exempt from CSA Certification 08-11-2021

# PLUMBIZER/MOUNTING OPTIONS

K282 BOSTONIAN - LED



KPL10

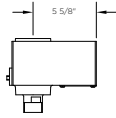

KPL11\*

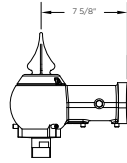

KPL20\*\*

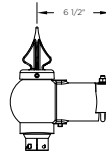

KPL21\*\*

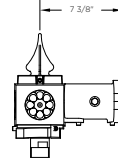

KPL30\*\*

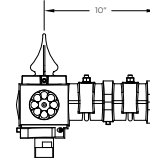

KPL31\*\*

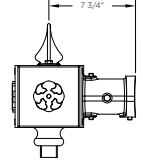

KPL40

\*Available with PR7

\*\*Available with PR7 or finial

## HOW TO ORDER

